

16" LINE

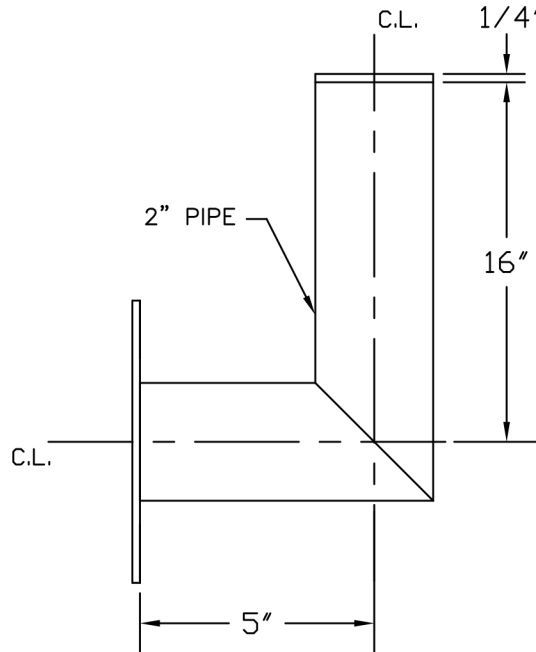

Design, PT&P 9/18/1999 7:55 AM IS-14

CLIENT NAME: _____
 PROJECT NAME: _____
 REQUISITION#: _____
 PT&P JOB#: _____ ITEM#: _____
 P.O.#: _____
 DWG#: _____
 REV#: _____
 MARK#: _____
 FINISH: _____
 DATE#: _____

FIGURE#: IS-590 (16" DIA. VERT. OR HORZ. LINE)
 DESCRIPTION: PRIMARY INSTRUMENT SUPPORT MODULE, PREFAB,
 SINGLE INSTRUMENT, U-BOLT SADDLE W/2" PIPE ©
 90 DEG. EXTENSION FOR 16" DIA. VERTICAL OR
 HORIZONTAL PIPE.

**PIPING TECHNOLOGY &
 PRODUCTS, INC.**

P.O. BOX 34506 HOUSTON TEXAS 77234
 3701 HOLMES RD. HOUSTON TEXAS 77051
 TELE#:(713)731-0030 FAX#:(713)731-8640
 http://www.pipingtech.com/ E-MAIL: info@pipingtech.com

